

# Haier

## *TFT-LCD TELEVISION OWNER`S MANUAL*

*MODEL: L42A9-AK*

Please READ this manual carefully before operating your TV, and retain it for future reference.

# Haier

Haier

# Haier

***Congratulations on your purchase, and welcome to the "family" !***

**Dear Haier product owner:**

Thank you for your confidence in Haier. You`ve selected one of the best-built, best-backed products available today. We`ll do everything in our power to keep you happy with your purchase for many years to come.

As a member of the Haier "family," you`re entitled to protection by one of the most comprehensive warranties and outstanding service networks in the industry.

thanks for investing in a Haier product.

# CONTENT

## **BEFORE OPERATING**

Warning.....	1
Important Safety Instructions.....	2
Buttons and interface location.....	4
Remote controller.....	6
Remote controller key function.....	7
Effective range of remote controller.....	8
External equipment connections.....	9

## **BASIC OPERATING**

Switching on/off the TV set.....	14
Select input modes .....	15
Searching channel.....	16
Watching TV program.....	18
Picture control functions.....	21
Sound control functions.....	23
Time functions.....	26
Function menu.....	28
Adjust menu.....	29

## **OTHERS**

Others functions.....	32
Stream media broadcast system.....	33
Specifications and functions.....	43
Maintenance.....	44
Troubleshooting.....	45

## **Accessories**



Remote controller



User's manual



Alkaline battery(AA)×2



Screws×8



Power cable



Bracket×4

# Warning

---



**WARNING**



## **WARNING**

TO REDUCE THE RISK OF ELECTRIC SHOCK DO NOT REMOVE COVER (OR BACK). NO USER SERVICEABLE PARTS INSIDE. REFER TO QUALIFIED SERVICE PERSONNEL.

\*To avoid electric hazards, it is strongly suggested that the back cover not be opened, as there is no any accessory inside the casing.

\*If necessary, please contact authorized after-sales services.

\*A lightning flash mark in a triangle: A potentially hazardous situation, which, if not avoided, could result in serious injury by high voltage.

\*An exclamation mark in a triangle: Major part or accessory of which technical specifications must be followed if it is to be replaced.

## **Warning:**

To avoid fire or electric hazards, never place your television receiver in an area with heavy moisture. Attention should be paid to avoid accidental scratches or impacts onto the LCD screen.

## **Caution:**

- ▲ Please read this manual carefully before using your television and keep this manual in a good place for future reference.
- ▲ To achieve the best performance of your television, read this User's Manual carefully and properly store it for future reference.
- ▲ Information of screen displays and figures in the User's Manual may vary due to technical innovations.

## **Caution:**

Unauthorized disassembly of this product is prohibited.

# Important Safety Instructions

The product should be tightly fixed to avoid drop damages and even fire.

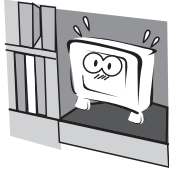

To avoid fire hazards, do not use this product under direct sunlight or closely to heat sources.

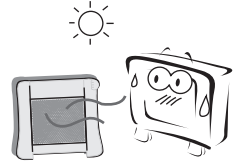

Do not locate the product close to water or oil, which may cause fire hazards.

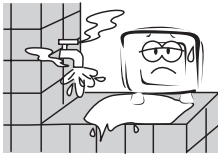

Unplug the power supply and antenna of the product when there is a rainstorm, especially Thunderstorm.



Do not use damaged or worn electric plugs, and keep electric cord away from heat sources to avoid electric shocks or fire hazards.



Do not connect excessive sockets in parallel or share the same socket by multiple plugs to avoid fire hazards.

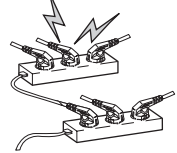

The product must be placed on a solid and stable surface to avoid collapse.

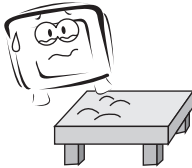

Unauthorized disassembly of the television is prohibited to avoid electric shocks or fire hazards. Contact authorized after-sales service if technical service is needed.

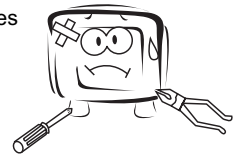

Keep the product away from a transformer or heat source to avoid fire hazards.

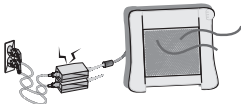

Disconnect the product from power supply and contact authorized after-sales service if abnormal sound is heard in the product.

# Important Safety Instructions

Don't use or store inflammable materials near the product to avoid explosion or fire hazards.

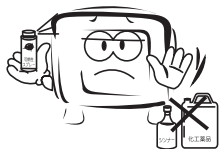

Don't place the product in a humid area to avoid fire hazards.

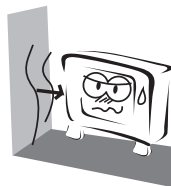

The antenna of the product should be away from electric cable to avoid electric shocks.

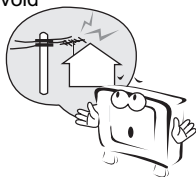

Never touch the plug when your hand is wet as this might cause electric shocks.



Always make sure that the television is well plugged as poor electric connection might cause fire.

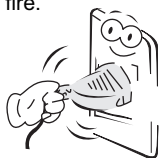

When antenna is used, measures should be taken to prevent water from flowing down along the cable into the television.



Unplug the television, use soft fabric, never chemicals, if you are going to make cleaning of the product. Make sure that no water drops in the product.



The plug and electric cable must be kept clean to avoid electric shocks or fire hazards.

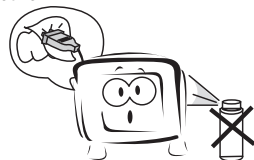

Disconnect the television from power supply and antenna when there is a rainstorm or thunderstorm to avoid electric shocks or fire hazards.



Disconnect the television from power supply to avoid electric shocks or fire hazards in a long vacation.

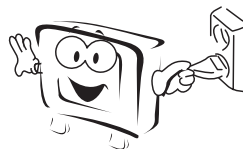

# Buttons and interface location

- This is a simplified representation of front panel.
- Here shown may be somewhat different from your TV.

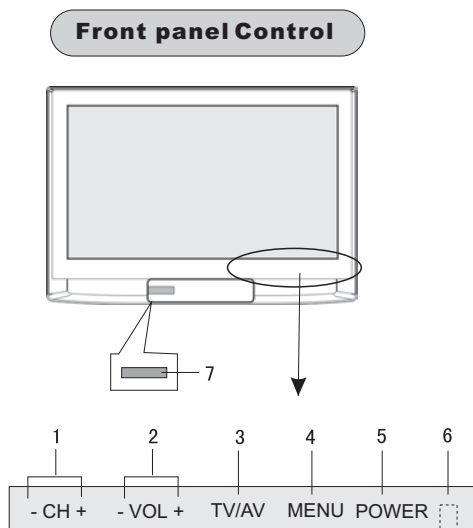

## Buttons and functions

- 1、 **Channel number increase and decrease.**
- 2、 **Volume decrease:**for lowering the volume or adjusting the menu.  
**Volume increase:** for enhancing the volume or adjusting the menu.
- 3、 **TV/AVbutton**
- 4、 **Menu button**
- 5、 **Power and indicator:** for turning on or off the power supply.
- 6、 **Remote receiving window**
- 7、 **Card jack**

# Buttons and interface location

## Rear panel Control

**USB Socket**

**VIDEO Input**  
Connects the video signal from a video device.

**AUDIO Input**  
connect to hear stereo sound from an external device.

**Switch:** power on/off

**Power Cord Socket**  
This TV operates on AC power. The voltage is indicated on the specifications page. Never attempt to operate the TV on DC power

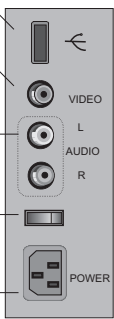
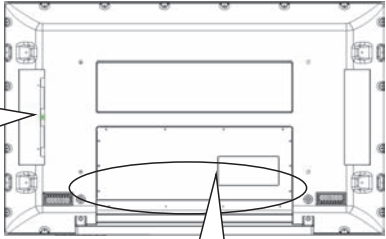
**External Speaker (8 ohm Output)**  
Connect to optional external speaker(s).

**EXT Subwoofer:**  
Subwoofer audio output terminal.

**DVD/DTV Input (Component)**  
Connect a component video/audiodevice to these jacks.

**Video/Audio output terminal**  
Connect ordinary video/audio or other appliance audio input terminals.

**Antenna Input**  
Connect cable or antenna signals to the TV, either directly or through your cable box.

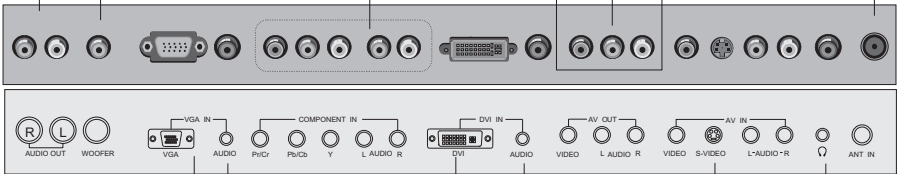

**VGA Input**  
Connect the monitor output connector from a PC to the jack

**Audio input**  
for linking PC or other appliance audio frequency output terminals.

**DVI Input**  
Connect the monitor output connector from a PC to the appropriate input port.

**Audio input**  
for linking DVI or other appliance audio frequency output terminals.

**Audio/Video Input S-Video Input**  
Connect audio/video or S-Video out from an audio/video or S-Video device to these jacks.

**Earphone jack**  
Earphone Audio output terminal



# Remote controller

## Battery loading

1. Slide open the cover of the battery compartment on the back of the remote controller.
2. Load two 5# alkaline batteries in the compartment. (plus and minus poles to respective mark)
3. Replace the cover of the battery compartment.

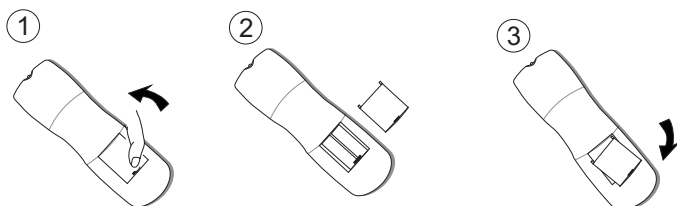

## Precautions

As strong light may interfere the signals, change your position to operate the remote controller if the television cannot be turned on or off as you expect.



Make sure that two AA alkaline batteries are loaded. The batteries must be of the same type. The batteries must be located properly. The batteries are not rechargeable.

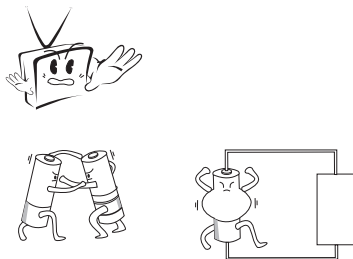

Keep the remote controller away from heat source or humid area to ensure effective performance of the remote controller.

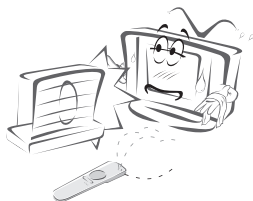

Make sure that there is no obstacle between the remote controller and television set.

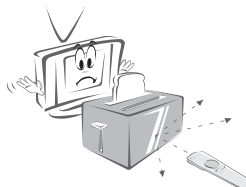

# Remote controller key function

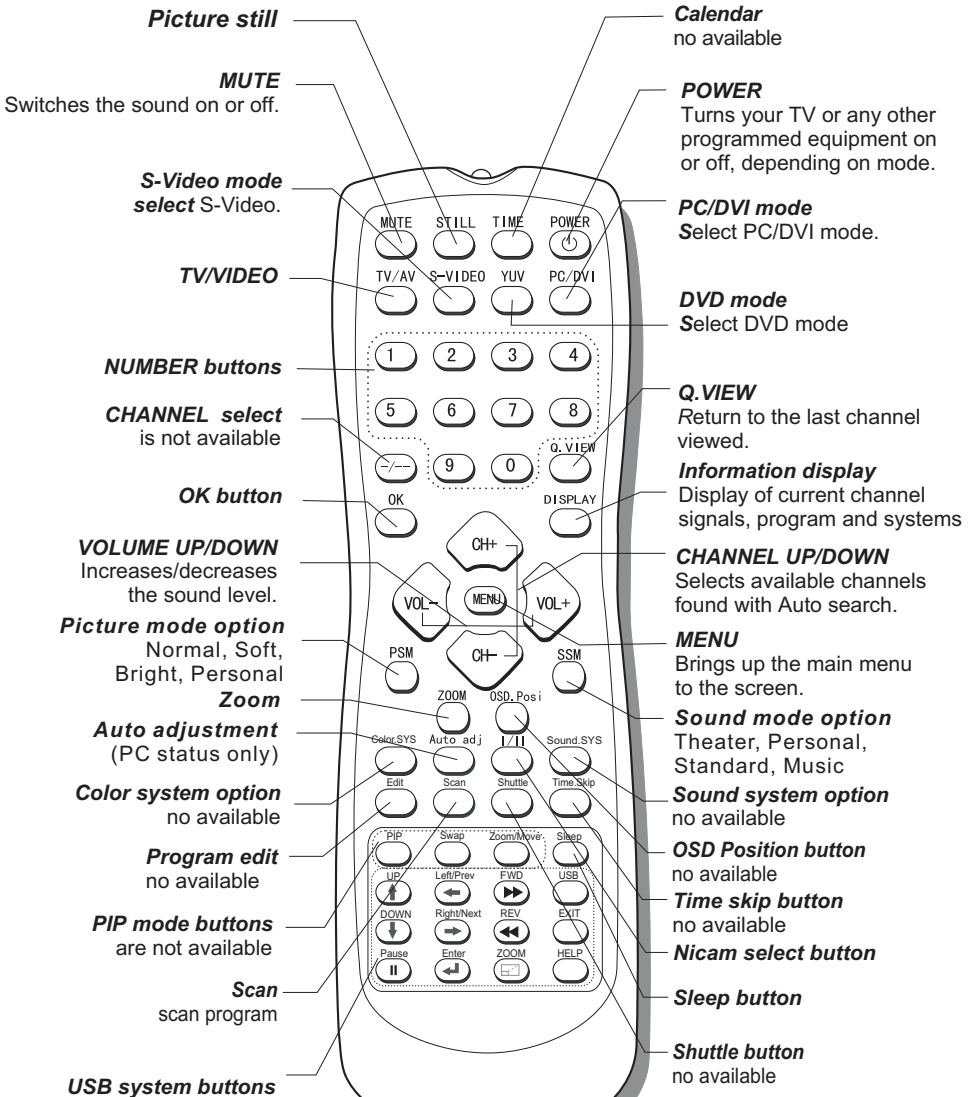

# Effective range of remote controller

## Effective range

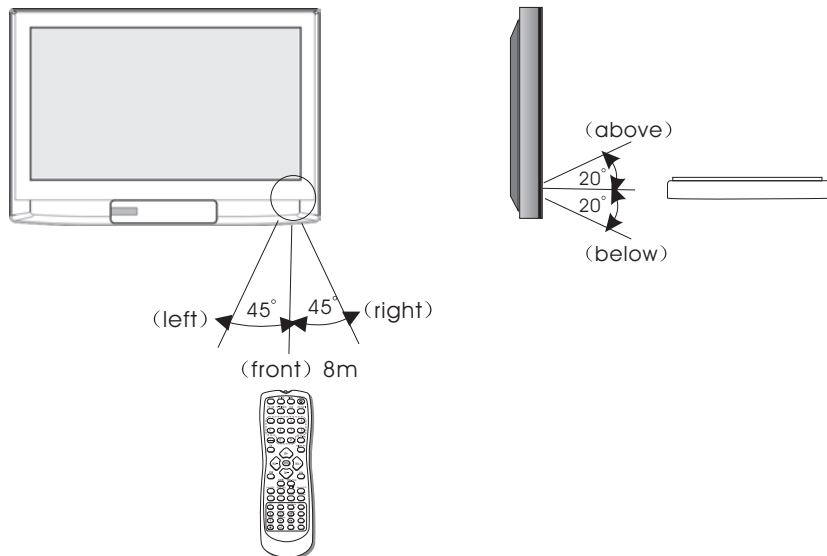

- Ensure the remote controller is pointed toward the remote controller windows on the display.
- No obstacles should be placed between the remote controller and the remote controller window.
- The effective receiving scope for the signal is 8 meters to the front of the remote controller windows, and 45° to the left or right side and 20° above or below the control windows.

### Use of remote controller:

1. To ensure a normal operation, the remote controller should not be dropped or damaged in any way .  
It should also be kept dry and away from all heat sources.
2. Battery replacement is necessary when the remote controller acts inconsistently or stops operating the display.

# External Equipment Connections

## Antenna Connection

- Antenna or Cable Service without a Cable Box Connections
- For optimum picture quality, adjust antenna direction if needed.

VHF UHF

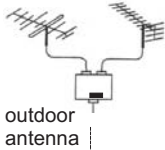

outdoor antenna

Single-family Dwellings /Houses  
(Connect to wall jack for outdoor antenna)



Antenna input  
(75Ω standard coaxial type)

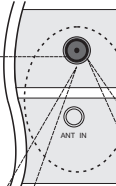

(Multi-family Dwellings/Apartments  
Connect to wall antenna socket)



300Ω twin-lead cable

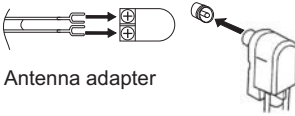

Antenna adapter

75Ω coaxial cable



Plug  
(additional purchase)

### Note:

- \* It is recommended that you'd better use 75Ω coaxial cable to remove the disturbance caused by airwave.
- \* Don't bind antenna cable and electric wire together.

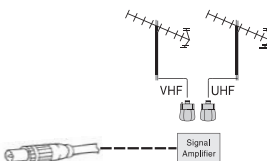

- To improve picture quality in a poor signal area, purchase and install a signal amplifier.
- If the antenna needs to be split for two Tv's, install a "2-Way Signal Splitter" in the connections.
- If the antenna is not installed properly, contact your dealer for assistance.

# External Equipment Connections

## DVD setup

### How to connect

1. Connect the DVD video outputs (Y, Pb/Cb, Pr/Cr) to the COMPONENT (Y, Pb/Cb, Pr/Cr) INPUT jacks on the TV and connect the DVD audio outputs to the AUDIO INPUT jacks on the TV, as shown in the figure.

2. If your DVD only has an S-Video output jack, connect this to the S-VIDEO input on the TV and Connect the DVD audio outputs to the AUDIO INPUT jacks on the TV, as shown in the figure.

**NOTE:** If your DVD player does not have component video output, use S-Video.

### How to use

1. Turn on the DVD player, insert a DVD.
2. Use the S-Video button on the remote control to select S-VIDEO mode.
3. Press Play button on external equipment for program play.
4. Refer to the DVD player's manual for operating instructions.

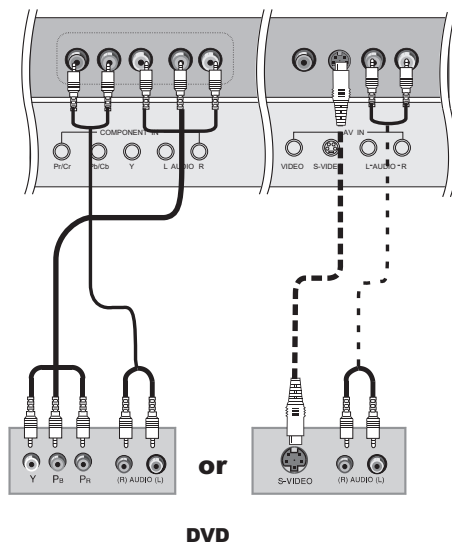

## DTV setup

-To watch digitally broadcast programs, purchase and connect a digital set-top box.

### How to connect

Use the TV's COMPONENT (Y, Pb/Cb, Pr/Cr) INPUT jacks, VGA or DVI port for video connections, depending on your set-top box connections available. Then, make the corresponding audio connections.

### How to use

1. Turn on the digital set-top box. (Refer to the owner's manual for the digital set-top box.)
2. Use YUV on the remote control to select YUV (Y, Pb/Cb, Pr/Cr) mode.
3. Press Play button on external equipment for program play.

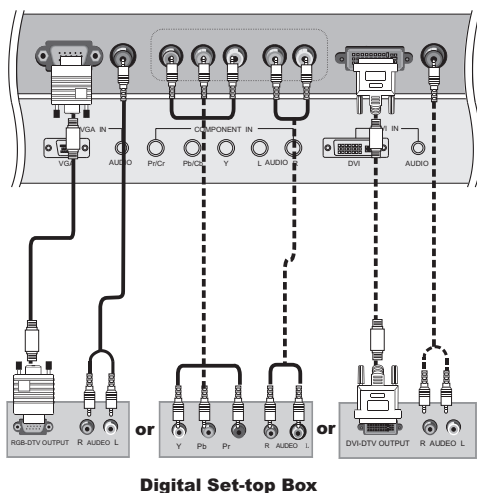

# External Equipment Connections

## PC setup

### How to connect

1. To get the best picture quality, adjust the PC graphics card to (L42A9-Ak->1024x768), 60Hz.
2. Use the TV's VGA INPUT or DVI (Digital Visual Interface) INPUT port for video connections, depending on your PC connector.
  - If the graphic card on the PC does not output analog and digital RGB simultaneously, connect only one of either VGA INPUT or DVI INPUT to display the PC on the TV.
  - If the graphic card on the PC does output analog and digital RGB simultaneously, set the TV to either VGA or DVI; (the other mode is set to Plug and Play automatically by the TV.)
3. Then, make the corresponding audio connection. If using a sound card, adjust the PC sound as required.

### How to use

1. Turn on the PC and the TV.
2. Turn on the display by pressing the POWER button on the TV's remote control.
3. Use PC/DVI on the remote control to select PC or DVI source.
4. Check the image on your TV. There may be noise associated with the resolution, vertical pattern, contrast or brightness in PC mode. If noise is present, change the PC mode to another resolution, change the refresh rate to another rate or adjust the brightness and contrast on the menu until the picture is clear. If the refresh rate of the PC graphic card can not be changed, change the PC graphic card or consult the manufacturer of the PC graphic card.

### NOTES:

1. Use a DVI cable.
2. Avoid keeping a fixed image on the TV's screen for a long period of time. The fixed image may become permanently imprinted on the screen.
3. The synchronization input form for Horizontal and Vertical frequencies is separate.

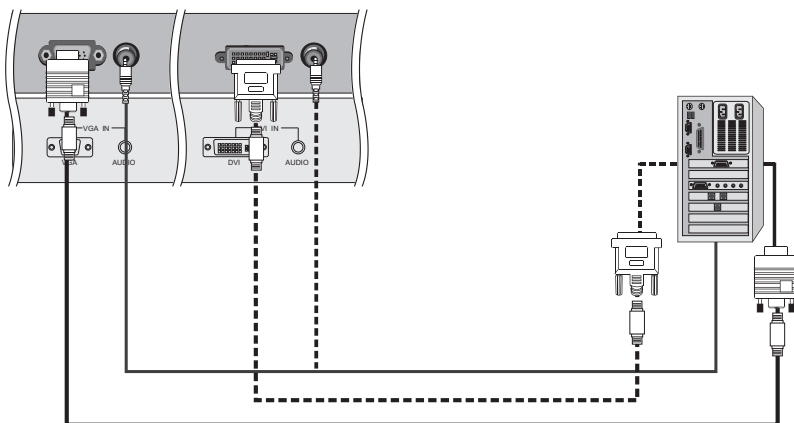

# External Equipment Connections

## Connect Loudhailer

1. Face the LCD screen upside down on a clean blanket or a bracket and pay attention not to indent the casing. Lay the two speaker aside of the LCD.
2. Lay annectent bracket on the speaker and hind rind, Fix 8 ST4X8 screws to the speaker and hind rind.
3. Connect the speaker cable to the speaker terminal of LCD TV and the speaker terminal, and insert the connecting cable into the terminal slot, Release the speaker terminal, and ensure that the white connecting cable is inserted in the terminal slot marked red and black connecting cable is inserted in the black terminal slot, and that anode and cathode poles are correctly connected.

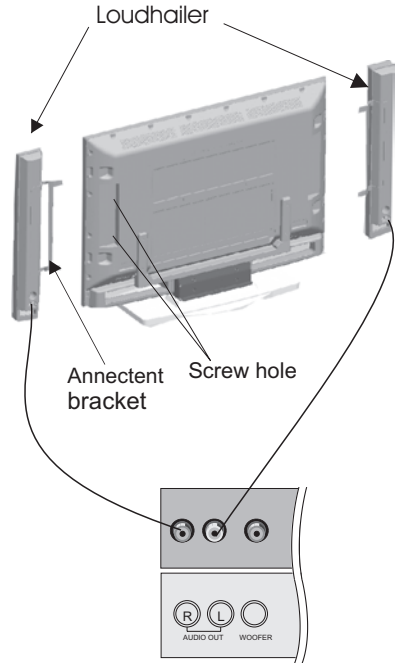

## Connect Woofer

1. Take the woofer out, and place it the hind rind. (See picture)
2. Connect cable to the woofer terminal and LCD TV terminal, and insert the connecting cable into the terminal slot.

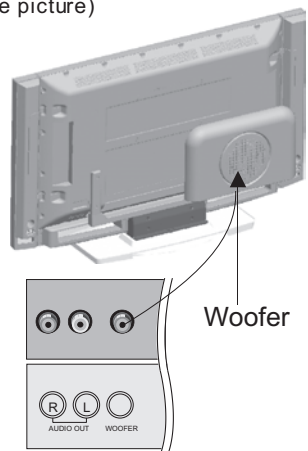

# External Equipment Connections

---

## Connecting Headphones

---

You can connect a set of headphones to your set if you wish to watch a TV programme without disturbing the other people in the room.

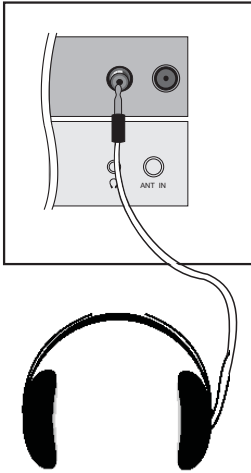

Plug a set of headphones into the 3.5mm mini-jack socket on the rear panel of the set.

### Note:

- Prolonged use of headphones at a high volume may damage your hearing.
- You will not receive sound from the speakers when you connect headphones to the system.

## Power source

---

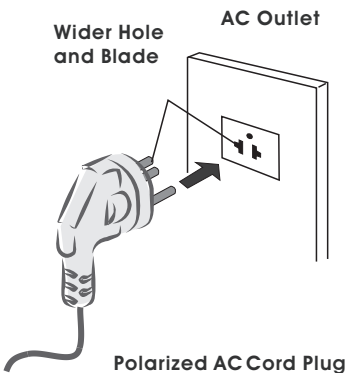

### TO USE AC POWER SOURCE

Use the AC polarized line cord provided for operation on AC. Insert the AC cord plug into a standard polarized AC outlet.

### NOTES:

- Never connect the AC line cord plug to other than the specified voltage. Use the attached power cord only.
  - If the polarized AC cord does not fit into a non-polarized AC outlet, do not attempt to file or cut the blade. It is the user's responsibility to have an electrician replace the obsolete outlet.
  - If you cause a static discharge when touching the unit and the unit fails to function, simply unplug the unit from the AC outlet and plug it back in. The unit should return to normal operation.
- Polarized AC Cord Plug.



# Switching ON/OFF the TV set

In the manual, the OSD (on screen display) may be different from your TV's because it is just an example to help you with the TV operation.

## Power ON/OFF

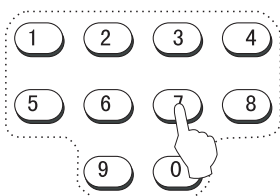
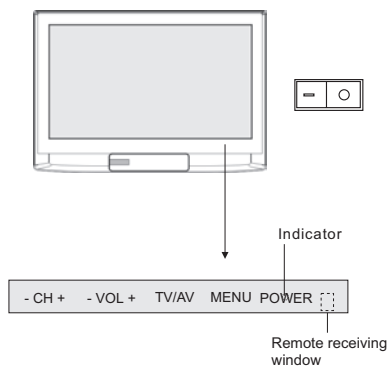

## Switching ON/OFF the TV set

1 Please press down the power switch to switch on AC power supply and the power indicator will light .

2 If the indicator is lighting in red, press POWER button on the remote control again.

3 If you want to exchange to standing by status, please press down POWER button on the remote controller.

4 If you want to fully switch off the power supply for the TV set, please press down the power switch button on the TV set.

## Choose the Menu Language

When you start using your set for the first time, you must select the language which will be used for displaying menus and indications.

1 Press **MENU** and **VOL+/-**-button to select the **FUN.** Menu.

2 Press **CH+/-**-button to select **Language**.

3 Select a particular language by pressing **VOL+/-** button repeatedly.

You can choose one of two languages. (Chinese or English)

4 When you are satisfied with your choice, press **MENU** button to return to normal viewing.

# Select input modes

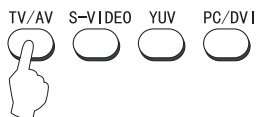

## Choose the input source

If you hope to enjoy the picture from the external input source, before to select the source, you need to connect the devices, otherwise, when you select the source, the none or no signal will appears on the screen.

Press **TV/AV** button on remote controller, the menu appears on the screen. Then press **CH+/-** to select the TV item, and press **VOL+/-** to ensure it.

Source
TV
AV1
Av2
YPbPr/YCbCr
VGA
DVI
USB

**TV:** the inputsource from ANT IN terminal output.

**AV1:** the inputsource from AV1 terminal output.

**AV2:** the inputsource from AV2 terminal output.

**YPbPr/YCbCr:** the input source from YPbPr terminal output.

**VGA:** the input source from VGA IN terminal output.

**DVI:** the input source from DVI IN terminal output.

**USB:** the input source from USB socket terminal output.

Before watching TV program, you need to ensure your TV in TV mode.

# Searching Channel

- This TV set has three methods to set channels, which are respectively full automatic, manual search, fine tune.
- In this section, how to use the remote control to set channel is explained. You can also use buttons on the TV set to set channel.

## Full automatic search mode

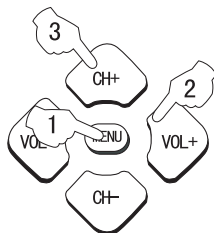

### Automatic search

1 Press the MENU button and VOL+/- button, till tuner menu shown on the right display on the screen.

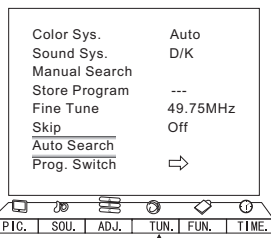

**Note** : the tuner menu will be only operated in normal TV mode.

2 Press the CH+/- buttons to select "Auto Search" item.

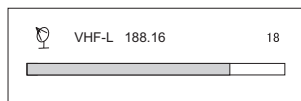

3 Press the VOL+ button to ensure automatic search function work.

After the search has finished, all channels now playing program will be automatically preset in order.

# Searching Channel

## Manual search

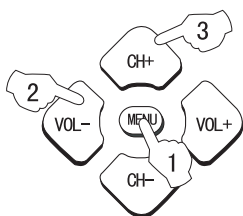
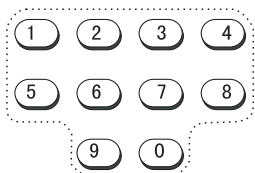

### Manual search

1 Press the CH+/- buttons or the PROGRAM NUMBER (0-9) button to choose desired channels (regard channel 1 as example) .

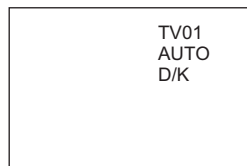

2 Press the MENU button and VOL+/- button, till the TUN. menu shown on the right display on the screen.

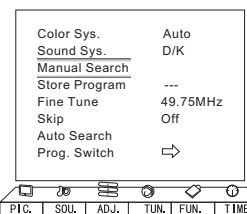

3 Press the CH+/- buttons to select "Manual Search" item.

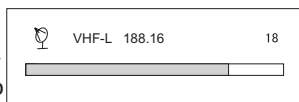

4 Press the VOL+/- buttons to start searching.

When searching successfully for the channel, the Manual search stopping automatically, at this time, press CH- button to select **Store Program**, then press VOL+/- to set the store.

### Fine tune

If the picture and/or sound are poor, try using the FINE TUNE feature. Do not use this feature unless reception is poor.

1 Repeat step 1-2, then press CH+/- buttons to select "Fine Tune" item.

2 Press VOL+/- buttons repeatedly to carry out fine tune, till the best picture and sound are obtained, then loosen the button.

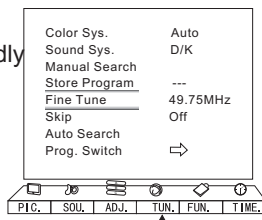

# Watching TV Program

You can watch TV program in a presetting channel.

## Watching TV program

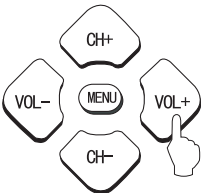
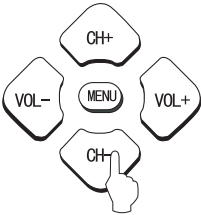
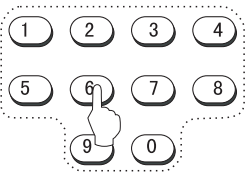
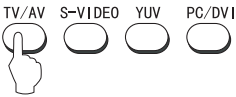

### To select the TV mode

Before watching TV program, you may ensure your TV in TV mode.

Press TV/AV button to select tv mode.

### How to select the desired program

#### 1 Using "Program number" buttons.

- Directly enter the channel number with the numeric keypad on the remote control.

If to select channel numbers of double-digit or three-figure , press continuously the numeric buttons in three second.

#### 2 Using the CH+/- buttons.

- Press the CH+ button to select a channel number in number increasing direction.

- Press the CH- button to select a channel number in number decreasing direction.

### How to select the desired sound

Press the VOL-/+ buttons on the remote or the front of the TV set to adjust the volume level. The range is 0~100.

When the volume buttons are pressed the volume level is displayed automatically on the TV screen.

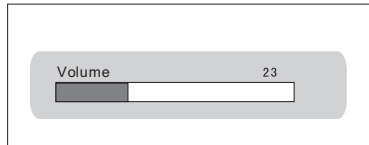

# Watching TV Program (continued)

## Watching TV program

### If the color of some channel is abnormal

Usually this should be set in the auto position. However if the color displayed on the screen are incorrect, you can manually select the correct color system.

Press the menu and VOL+/- button, till the picture menu shown on the right will display on the screen.

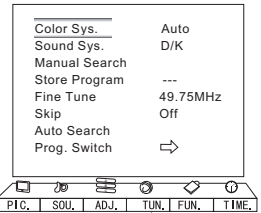

### If picture color is abnormal

Press the CH+/- buttons to select "color sys.", then press the VOL-/+ buttons to select the correct color system. In general, you can set it as "AUTO".

### If sound is abnormal

Press the CH+/- buttons to select "sound sys.", then press the VOL-/+ buttons to select the correct sound system. In general, you can set it as "D/K".

## Skip

After the programs are presetting, you can skip some programs so that to select your favorite channels only.

1. Press CH+/--button or Direct-digit choosing button to select a channel directly (take channel 18 for example).
2. Press MENU、CH+/--and VOL+/- button, till the TUN. menu shown on the right will display on the screen.

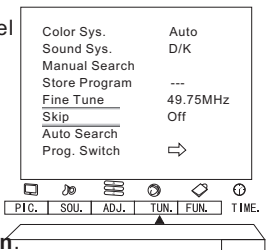

3. press VOL-/+ button to set Skip On.
4. press MENU exit.

### If you want to recover the skipped channel

1. Use Direct-digit Choosing button to select the number of the channel to be recovered.
2. Do the above steps again.
3. Press VOL+/--button to set Skip OFF.

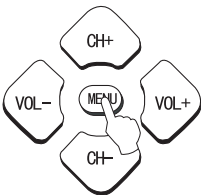
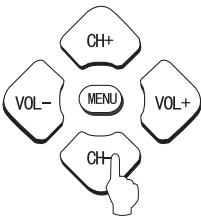

# Watching TV Program (continued)

## Watching TV program

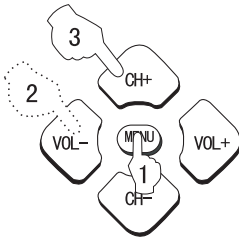

### Prog. Switch

1. Press MENU, CH+/- and VOL+/- button, till the **TUN.** menu shown on the right will display on the screen.
2. Press CH-/+ button to select **Prog.Switch**.
3. Press VOL+ to enter the submenu, and press the digital button to set the desired channel number, Press CH+ button to To Prog. Press the digital button to set the exchange channel number, press CH+ button to Switch, then press VOL+ button to ensure.
4. press MENU exit.

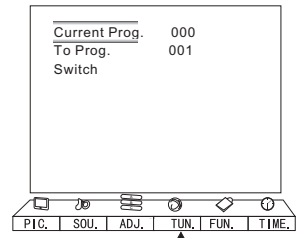
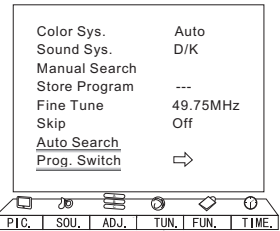

### Quick program view

This function enables quick swap to the last watched program.

1 Suppose the channel number you used just now is 8 and the channel number you are using is 18 (as shown in the figure).



2 If you want to return to the last watched program channel 8, you can simply press the Q.View button.



3 If you want to return to channel 18, press the button again. Use this function, you can easily change between the channel you are using and the channel you used last time.

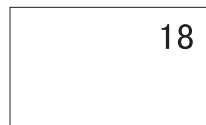

#### Q. VIEW



# Picture Control Functions

## Multiple picture modes

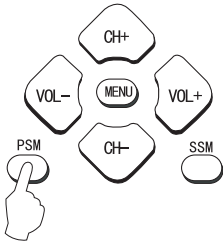

### How to select picture modes

You can quickly select the desired picture mode from three preset modes and one customized mode.

Press the PSM button to select the desired picture quality. Four kinds of picture modes (i.e., "Normal", "Soft", "Personal", "Bright") can be selected in turn.

PIC. Mode
Bright
Normal
Soft
Personal

The 4 modes are

Picture mode	Picture quality
Personal	A spare setting that can be adjusted to personal tastes
Normal	Designed for rooms that have good all round lighting
Soft	Designed for nighttime low light viewing
Bright	Designed for rooms with high ambient lighting such as daytime sport;

### How to customize your own picture status

- 1 Press the MENU button and VOL+/VOL- button, till the **PIC** menu shown on the right display on the screen.

Mode	Personal
Contrast	50
Brightness	50
Chroma	50
Hue	0
Sharpness	50
BackLight	50
DNR	Auto



- 2 Press the CH+/- buttons to select the item to be adjusted, then press the VOL-/+ buttons to obtain the desired effect.

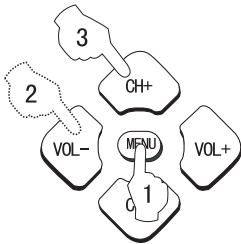

ITEM	Press VOL-	Press VOL+
Brightness	Dark	Bright
Contrast	Weak	Strong
Sharpness	Soft	Sharp
Chroma	Shallow	Deep
Hue(only in NTSC mode)	More purple	More green
BackLight	Green	Red

**NOTE :** these items are adjustable only under the "personal" setting.



# Picture Control Functions

## Multiple picture modes

### DNR( Digital Noise Reduction)

*Automatically filters out and reduces the image noise and improves picture quality when receiving weak video signals.*

1 After calling up the Picture menu, press CH+/- button to select "DNR" item.

2 Press VOL+ to enter the list. Select **Off**, **Auto**, **Weak**, **Medium** or **Strong** according to the image noise.

3 Press MENU return to the picture menu.

Mode	Personal
Contrast	50
Brightness	50
Chroma	50
Hue	0
Sharpness	50
BackLight	50
DNR	Auto

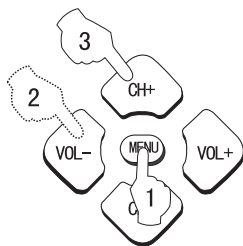
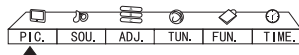

### In other modes

TV/AV1/AV2/USB

Mode	Personal
Contrast	50
Brightness	50
Chroma	50
Hue	0
Sharpness	50
BackLight	50
DNR	Auto

Only N system. ←

YPbPr/YCbCr

Mode	Personal
Contrast	50
Brightness	50
Chroma	50
Hue	0
Sharpness	50
BackLight	50
DNR	Auto

→ No adjustable

VGA/DVI

Mode	Personal
Contrast	50
Brightness	50
Chroma	50
Hue	0
Sharpness	50
BackLight	50
DNR	Auto

No adjustable

# Sound Control Functions

## Multiple sound modes

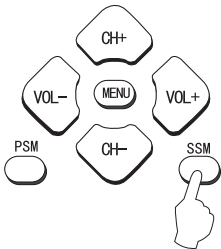

### How to choose sound mode

Press the **SSM** button to select the desired sound quality. Four kinds of sound modes (i.e., “Standard” , “Theater” , “Personal” ,and “Music” ) can be selected in turn.

SOU. Mode

Music  
Standard  
Theater  
Personal

Sound mode	Sound quality
Personal	A spare setting that can be adjusted to personal tastes
Standard	normal sound with moderate bass and treble setting
Music	Designed to reduce the bass and treble which enhances the voice for news programs
Theater	Enables extra bass and treble to enhance the movie experience;

### How to customize your own sound quality

1 Press MENU button and VOL+/- button , till the **SOU.** menu shown on the right display on the screen.

2 Press CH+/- buttons to select the item to be adjusted, then press VOL-/+ buttons to obtain the desired effect.

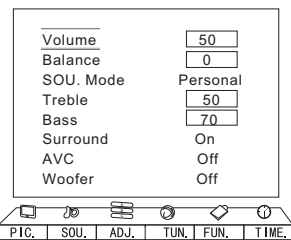

**Treble:** Increases or decreases the treble.

**Bass:** Increases or decreases the bass.

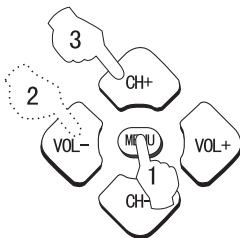

# Sound Control Functions

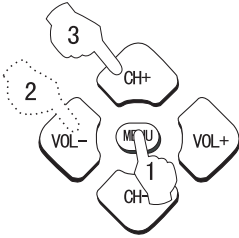

(Continue)

## Balance

*This will adjust the output of the right and left speakers to obtain the best stereo reproduction for your listening position.*

The intermediate value is 0. When indication value of Balance increases toward +50, sound of the right and left speaker becomes stronger and weaker, respectively. When indication value of Balance decreases toward -50, sound of the right and left speaker becomes weaker and stronger.

Press CH+/- button to Select **Balance**,  
Press VOL+ button to increase the audio output in the right speaker;  
press VOL- button to increase the audio output in the left speaker.

## surround sound

*The surround sound feature expands the audio listening field wider and deeper to create exceptional sound quality from the TV's speakers.*

Press CH+/- button to Select **Surround**,  
press VOL+/- button to set Surround as **Off** or **On**

## AVC( Auto volume control)

*Each broadcasting station has its own signal conditions, and so it is not easy for you to adjust the volume every time the channel is changed. This feature lets you automatically adjust the volume of the desired channel and reduces the volume differences between channels and programs, providing a more constant overall level. This will also reduce the dynamics of sound.*

Press CH+/- button to Select **AVC**,  
press VOL+/- button to set Surround as **Off** or **On**

## Woofersound

*Woofers is a speaker that complements front speaker's reproduction capability of low-pitched sound.*

Press CH+/- button to Select **Woofers**,  
press VOL+/- button to set Surround as **Off** or **On**

## Mute

### How to eliminate sound

*When you need to pay attention to surrounded sounds, or there is a telephone calling you or there are some guests visiting you, the sound elimination (mute) function is very convenient.*

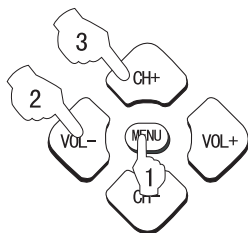

**1** Press the MUTE button on the remote control and "MUTE" type face will display on the lower part of the screen. At this time, the sound of the TV set is turned off.



**2** If you want to recover the sound, press the MUTE button again or directly press the VOL-/+ buttons.



# Time Functions

## Clock setting and timer on/off functions

### Clock setting

The clock will only work if the TV set is turned on or in standby. When the set is disconnect from the power supply or is turned off by the main power on the rear panel, the clock loses power and will need to be reset when the power is reconnected.

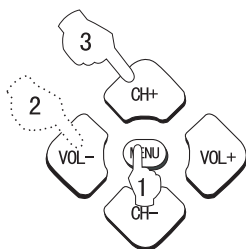

**1** Press MENU button and VOL+/- button, and the **TIME** menu display on the Screen.

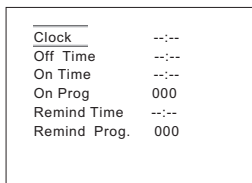

**2** Press CH+/- buttons select "**Clock**", press VOL -/+ buttons to select hour or minute position, then press the digital buttons to set the value of hour or minute;

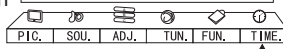

### On/off timer

Using on/off timer function, the TV set can automatically turn on to a preset program or shut down in a preset time.

**1** Press CH+/- buttons to select "On time", press VOL -/+ buttons to select hour or minute position; then press the digital buttons to set the value of hours or minutes.

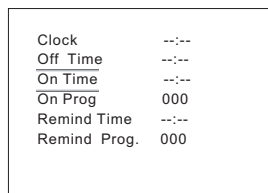

**2** Press CH+/- buttons to select "On prog", then press the digital buttons to select your desired channel.

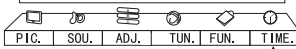

**3** Repeat step 1-2 to set "Off time" .

Indication will appear on the screen 1 minute prior to expiry of set time.  
Suppose Timer Off is set, and indication is as follows:

Timer Off

When the above indication appears on the screen, set time may be changed if VOL+/- button is pressed.

#### NOTE:

**1.** If Clock option is setting, the time you set for Off Timer / On Timer will be a point of time. Otherwise, if Clock is not set, the time you set for Off Time / On Time will be a period of time.

**2.** Sleep Off / Off Time can not be set simultaneously. If both of the two are set, the later setup will be operation.

# Time Functions

## Remind Time and Remind Program setting

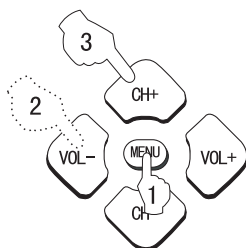

### How to use the remind time and program

Program remind timer, that displays an on-screen reminder prompt, when a program on a different channel is due to start.

**1** Press MENU and VOL+/- button to call up the **TIME** menu on the screen.

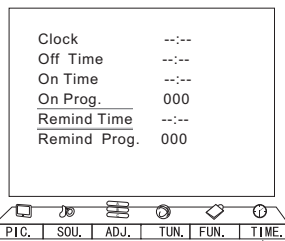

**2** Press CH+/- buttons to select "**Remind Time**", then press VOL -/+ buttons to select hour or minute position; then press the digital to set the value of hour or minute.(take 19:30 as an example)

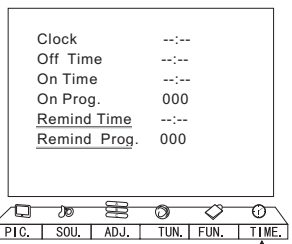

**3** Press CH+/- buttons to move the cursor to "**Remind Prog.**", then press the digital buttons to set the desired channel.

# Function menu

It is possible to select language, OSD transparency, menu timeout, calendar, 3A optimize, time skip.

## Function menu operation

1. Press MENU and VOL+/- button to enter the FUN. Menu.
2. Press CH+/- to select desired item.
3. Press VOL+/- button to adjust the values level.
4. Press menu to exit.

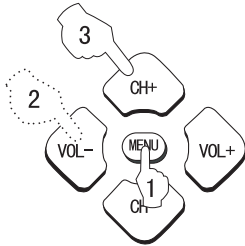

Language	English
Menu Timeout	15seconds
Menu Background	Translucent
Blue Screen	Off
Calendar	
3A Optimize	Off
Time Skip	0Min

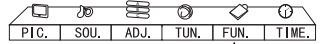

No adjustable in YPbPr/YCbCr/VGA/DVI/USB modes

No adjustable in AV/AV2/YPbPr/YCbCr/VGA/DVI/USB modes

## Menu Timeout

Repeat step 2 and 3 to set the menu out time. Each Press of VOL+/- button repeatedly to select the number of preset minutes, the time will be set in sequence: 5seconds, 10seconds, 15seconds, 20seconds, 25seconds, 30seconds, 40seconds.

## Menu Background

Repeat step 2 and 3 to select semi transparency and opaque background of OSD.

## Blue Screen

Repeat step 2 and 3 to select Blue Screen. If you select ON, when no signal, the background is blue; if you select OFF, when no signal, the background is dark.

## 3A Optimize

Repeat step 2 and 3 to set the **3A optimize** as **on** or **off**.

The 3A optimize tracks picture contrast and color to improve the quality of picture in terms of brightness and sharpness.

## Calendar

Repeat step 2 to select the **Calendar**, press VOL+ button to search the desired year or month.

Press CH+/CH- button to adjust the desired year or month.

1981-01-01						
Sun.	Mon.	Tue.	Wed.	Thu	Fri.	Sat.
				1	2	3
4	5	6	7	8	9	10
11	12	13	14	15	16	17
18	19	20	21	22	23	24
25	26	27	28	29	30	31

# Adjust menu

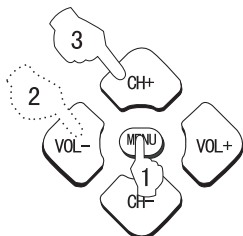

1. Press MENU and VOL+/- button to enter the ADJ. menu.
2. Press CH+/- to select desired item.
3. Press VOL+/- button to adjust the values level.
4. Press menu to exit.

Display Mode	Normal
Adjust	⇒
RGB	⇒
Default	
Auto Sync.	
Color Temperature	Normal
Black Stretch	On

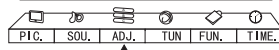

## Display Mode

Repeat step 2 and 3 to set the Display Mode.

### 4:3

Choose **4:3** when you want to view a picture with an original 4:3 aspect ratio, with black bars appearing at both the left and right sides.

### Wide Screen

Choose **Wide Screen** when you want to adjust the picture horizontally, in a linear proportion to fill the entire screen.

### Normal

Choose **Normal** when you want to view the picture without any alteration. However, the top and bottom portions of the picture will be cropped.

You can also press **ZOOM** button on remote controller to select the desired picture ratio.

## Color temperature

Repeat step 2 and 3 to set the **Color temperature**.

There are four kinds of modes (i.e., "**Normal**", "**Cold**", "**Green**", "**Warm**") can be selected in turn.

This will increase or decrease **Warm** (red) and **Cool** (blue) colors to suit personal preferences. Select **Cool** to give the white colors a blue tint, **Normal** to give the white colors a neutral tint, **Warm** to give the white colors a red tint. **Green** to give the white colors a green tint.

## Black Stretch

Black Stretch-(Automatically Increases the Contrast Rage)

Repeat step 2 and 3 to set the **Black Stretch**.



# Adjust menu

In VGA and DVI input mode, H-Position and V-Position can be adjusted to eliminate transverse line interference and decentered picture.

## PC setting

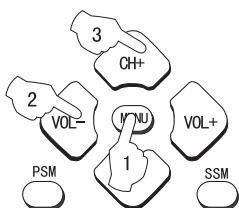
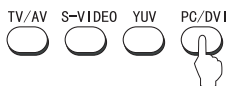

## PC setting

Press PV/DVI button to select PC or DVI mode.

1 Press MENU button and VOL+/VOL- button, till the ADJ. Menu display on the screen.

2 Press CH+/- buttons to select the item to be adjusted, then press VOL+/- buttons to adjust.

Only be adjustable in the VGA/DVI mode.

Display Mode	Normal
Adjust	⇒
RGB	⇒
Default	
Auto Sync.	
Color Temperature	Normal
Black Stretch	On

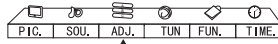

## Adjust

This will adjust the picture of H-position, V-position, H-size, V-size and Fine Tune.

Press CH+/- buttons to select **Adjust**, then press VOL+/- buttons to enter the sub menu.

H Size	0
H Position	0
V Size	0
V Position	0
Fine Tune	0

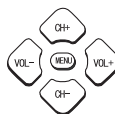
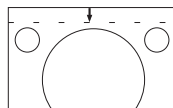
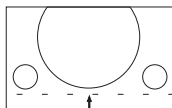
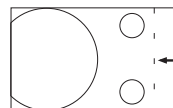
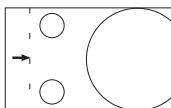
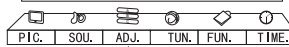

### Note:

- As adjusting H position or V position parameter, It is natural that the picture will have faintness once in a while if the range is more, then to adjust contrarily to normal position.
- H-position, V-position, Auto Adjust are not available in TV mode.
- Auto Adjust is not available in AV and S-VIDEO mode.

- H Size:** Horizontal size of picture can be adjusted in this item.  
**H Position:** Horizontal position of picture can be adjusted in this item.  
**V Size:** Vertical size of picture can be adjusted in this item.  
**V Position:** Vertical position of picture can be adjusted in this item.  
**Fine Tune:** Adjust phase to the best effect suiting for VGA signal.

# Adjust menu

In VGA and DVI input mode, H-Position and V-Position can be adjusted to eliminate transverse line interference.

## Multiple picture position setting

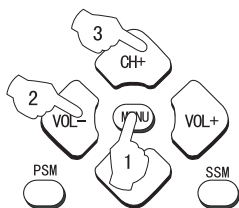
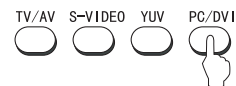

(Continue)

### PC setting

1 Press CH+/- buttons to select **RGB**, then press VOL-/+ buttons to enter the sub menu.

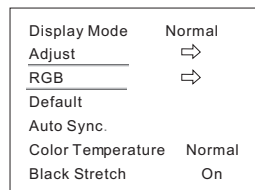

2 Press CH+/- buttons to select the desired item, press VOL+/- button to adjust.

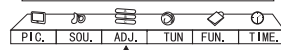

**RGB** is opted for adjustment of the numerical value of red, green and blue in VGA/DVI mode.

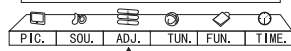
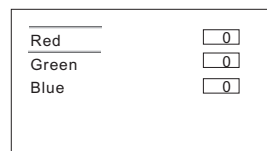

### Default

This is opted for adjustment of parameters to delivery setup in VGA mode.(After the operation, complete will be on the right of the operation)

Repeat step 1 and 2 to set the **Default**.

### Auto Sync

This is opted for adjustment of picture location frequency and phase parameters in VGAmode.(After the operation, complete will be on the right of the operation)

In VGA ,if no signal input, the Auto Sync will be no adjustable.

Repeat step 1 and 2 to set the **Auto Sync**.

### Note

Recommendatory frequency as follow:

Sequence	frequency	H-frequency (KHz)	V-frequency (Hz)	Remark
1	640*480@60Hz	31.5	60	DOS
2	800*600@60Hz	37.88	60	VESA
3	1024*768@60Hz	48.36	60	VESA

*NOTE : As the frequency of display differ in PC device, you may select the appropriate frequency to obtain desired effect. If the signal of receive is excess, the picture can be not displayed or wrong on the screen.*

# Others functions

## Program Edit、Scan、Nicam and display functions

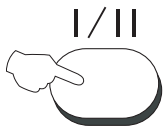

### NICAM

Press the **I/II** button will result in fast swap of **NICAM** function of current program.

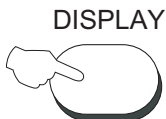

### Display function

Press the **DISPLAY** button, then the channel number and system will be displayed on the screen. Press the **DISPLAY** button again, it is disappear.

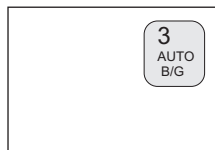

### Scan

**1** If you want to select a desirable program, you may scan all the TV programs in memory. You can simply press **SCAN** button to do this. Press scan button once, there are nice pictures on the screen, press Scan button again, there are sixteen pictures on the screen to scan.

**2** If you want to stop the function during auto tuning, simply press **SCAN** button again.



### Sleep

The TV set will switch automatically to standby at the preset time with the **SLEEP** time on. You may set the sleep time.

each press of **SLEEP** button repeatedly on the remote control to select the number of preset minutes, the timer will be set in sequence: (**0min, 5min, 15min, 30min, 60min, 90min, 120min**).

After the sleep time is programmed, the display will appear briefly every ten minutes to remind you that the sleep timer is operating.

To confirm the sleep timer setting, press **SLEEP** and the remaining time will be displayed for a few seconds.

To cancel the sleep timer, press **SLEEP** repeatedly until the display turns to **0 min**.

# Stream media broadcast system

## Stream media play prepare

### 1. Supporting equipment

1. Equipment supporting Mass and Storage agreements include USB, mobile hard disk, card reader, some MP3 and digital camera.

2. Equipment supporting PTP agreement includes some digital camera.

#### 2.1 Supporting media:

picture, music, MPEG4, MPEG2 and MPEG1;

#### Supporting file format:

\*.Avi, \*.DIVX, \*.MPEG, \*.DAT, \*.MP3, \*.WMA, \*.JPG and \*.JPEG. Due to particularity of filecode and file mode, it is possible that some files cannot be read.

2 If Pic & Music mode is activated, relative media file format will include JPEG and MP3 files. After Picture is selected, MP3 files set for play will open both music and picture files for sync play performance. As some files must be read while music is being played, the speed of picture operation response might be affected.

3. Before starting operation, verify USB storage device is of FAT32 and FAT file system format. At present, this television does not support NTFS and the filesystems of other format.

4. Many movie files use suffix of AVI and MPG. However, many kinds of format

are used for internal files. This television can only play some AVI and MPG files of this format. Those files with suffix of dat are not movie files, but data files used by computers, and cannot be played for movies.

5. External card reader supports most digital cards available in the market. Readable digital cards are classified according to the property of card readers and can be connected to mobile hard disks (working voltage 5.0V, working current not over 500mA).

6. Some time the television operation may be halted due to excessive rate of information code errors. In such case, restart the system. As there are many nonstandard USB mobile devices in the market. If this kind of USB mobile devices are used in the stream media play system, the problem of identification failure might occur. The same problem may also happen with computers, not televisions.

7. It is suggested that the external devices with USB2.0 interface be used to improve reading velocity of information reading and continuity of information play.

# Stream media broadcast system

## Stream media system setup

**Note:** Memory cards or USB devices are not supplied with this TV.

### USB setup

- 1 Insert USB in the card slots at the right side the TV.
- 2 Insert it to be clicked in.
- 3 Press USB button on the remote controller to enter the stream media system.

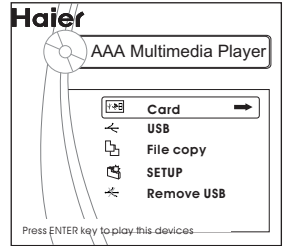

### CARD setup

This TV is Compatible with the card of SD/MMC/CF/MS/SM format.

### How to use

#### 1、 Jack of card Instructions:

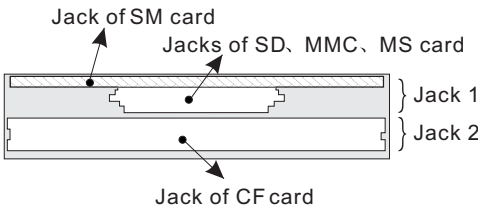

#### Note

1. Please note chooses uses the digital memory card with you corresponds the receptacle
2. Card reader in 1 cannot simultaneously insert two kind of cards in the graphical representation position

#### 2、 Insert the card as right direction. As following Card in common use

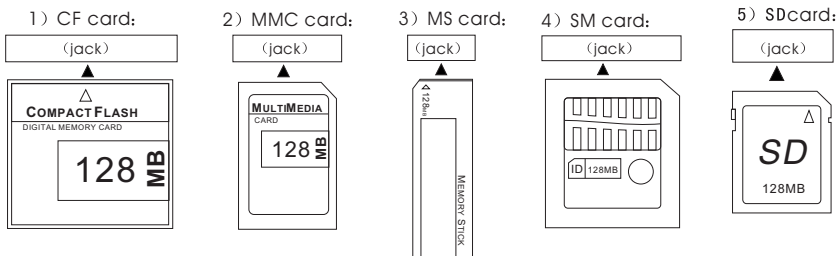

#### Note:

1. the card insertion time, after the flows media system starts 2s, insert the card to numerical code card reader, do not bring card to start flow media system.
2. After card insertion, indicator light will shine, and enters glitters condition, after period of time, indicator light enters constant bright condition, indicates already distinguishes finished, this time carries on play operation and so on.
3. In the market, the digital card type are very many, please uses standard product of the standard factory, meets reads takes difficult or reads speed limits, please replaces the digital card.

# Stream media broadcast system

## Removing USB device

- 1 Press Up ↑ or DOWN ↓ to select Remove USB, and press ENTER button to ensure it.
- 2 press EXIT button to exit menu.
- 3 Remove the memory card/USB device.
- 4 If to remove the card device, press EXIT button to return to the main menu, and remove the card.

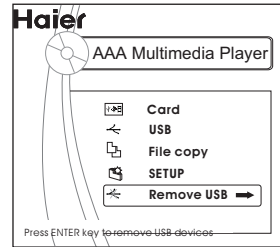

## Card data protection

- Do not remove the card/USB device when the content is being read or when browsing. Such action may damage the memory card/USB device.
- Do not touch the terminals on the back of the card.
- Always insert a card in the correct direction. Failure to do so may result in damage to the card and the unit.
- Do not subject the card to excessive pressure or strong impacts.
- Malfunctions of the unit or card may result in data loss or damage to the card.
- Haier shall not accept any liability for damage or loss of stored data.



### **Warning:**

Memory cards can be swallowed by young children. Do not allow children to handle memory cards. Please remove the memory card immediately after use.

# Stream media broadcast system

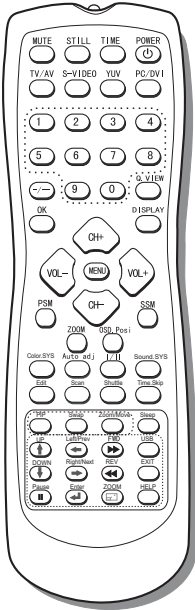

## To start the media play

1. Press USB button to enter media play system.
2. Press Up ↑ or DOWN ↓ button to select the desired option.
3. Press ENTER ↵ button to enter desired option.
4. Press EXIT to return the previous menu.
5. If to exit USB system, you need to return to the main menu to protection card data..

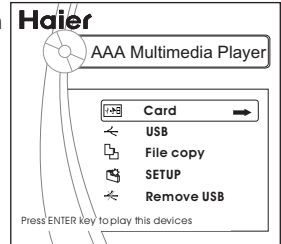

**Note:** If there are no operation two minute later, the TV will enter the saver automatically, at the time, press any button of USB system to exit the saver menu.

## To operate the menu

1. Press Up ↑ or DOWN ↓ to select the item with up or down.
2. Press LEFT ← or RIGHT → to select the desired item of submenu with left or right.
3. Press ENTER ↵ button to ensure the desired option, to enter the submenu, to resume the speed of standard.
4. Press FWD ►► or REV ◄◄ button to operate play quickly or slowly.
5. Press PAUSE || button to make the program stop, and press again to resume it.
6. Press ZOOM ◻ button to make zoom, and press Left/Right or UP/DOWN button to enjoy the detail.
7. Press HELP button to call up or exit the OSD information. And press HELP button to call up or exit the OSD during operating file copy.
8. Press EXIT button to return to previous menu and stop play, press EXIT button repeatedly to return to main menu.

# Stream media broadcast system

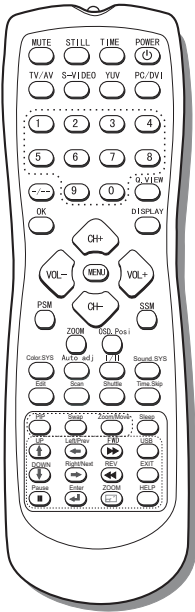

**Note:**  
the play file menu are different with your USB devices.

## To select stream media broadcast system

1. Press Up ↑ or DOWN ↓ button to select "card" or "USB". (The device be inserted and identified).
2. Press ENTER ↵ button to enter adjusted option.

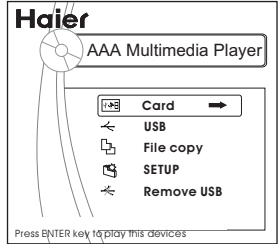

## To play picture

1. Press Up ↑ or DOWN ↓ button to select Picture item.
2. Press ENTER ↵ button to enter the menu of play.
3. Press again Up ↑ or DOWN ↓ button to select desired enjoy picture, and then press ENTER ↵ button to enter the play menu.
4. On screen display, Press Up ↑ or DOWN ↓ to select the speed of play. (Normal, slow, fast).
5. Press LEFT ← or RIGHT → button to swap the picture of next and previous. Press EXIT button to return.

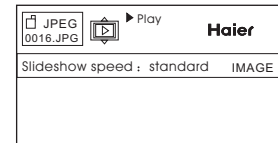
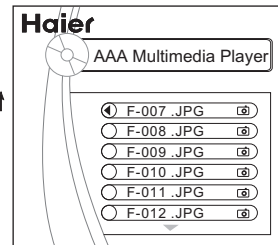
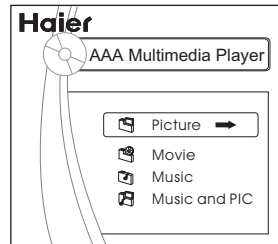

## To enjoy the picture detail

1. After selecting the picture to play, press ZOOM to select desired zoom.
2. Press HELP button to exit the display, and then press Up ↑ or DOWN ↓ or LEFT ← or RIGHT → to move and enjoy the picture detail.

## To make the picture overturn

Each press of FWD ►► button to make overturn 90° with right, press ENTER ↵ button to resume the program playing.



# Stream media broadcast system

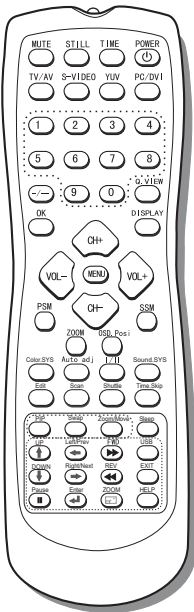

## To enjoy music

1. Press UP/DOWN button to select "Music" option.
2. Press ENTER button to enter play menu.
3. Press UP/DOWN button to select desired music, and then press ENTER button to play music.

**Note:** the play file menu are different with your USB device.

4. When playing music, press UP/DOWN to select play mode, (play mode: standard, program, Random; Repeat mode: Disc Repeat, Folder Repeat, File Repeat) and press ENTER button to ensure the mode.

5. When playing music, press ← or → button to swap the next and previous music
6. Press EXIT button to exit the playing.

**Note:** 1. **DISC Repeat mode:** press UP/DOWN button, the DISC Repeat will appear on the screen, and then press ENTER to ensure it.

2. **Program mode:** press UP/DOWN button to select the music in left list, and press ENTER button to program in turn, and then the DISC Repeat will appear on the screen, and then press → button to select "Done", and then press ENTER button to ensure it.

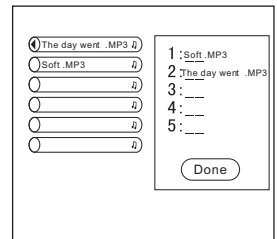
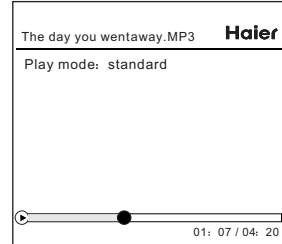
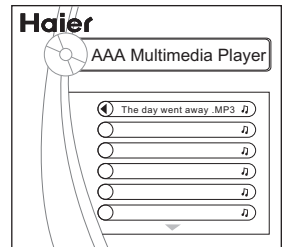
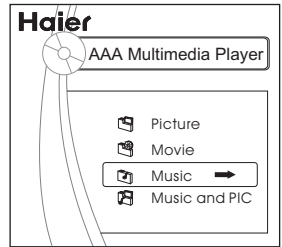

# Stream media broadcast system

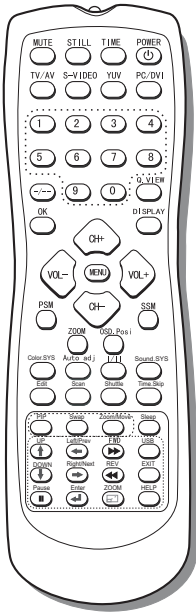

## To play Movie

1. Press UP/DOWN button to select "Movie" option.

2. Press ENTER to enter play menu.

3. Press again UP/DOWN button to select desired music, and press again ENTER button to play it.

4. On screen display, press ← or → button to select in turn:

**File-Play Back Control-Auto channel-Play Mode**

5. Press FWD▶▶ or REV◀◀ button to set speed, press ENTER button to resume to standard mode.

6. Press ← or → button to select the next movie or previous.

7. Press EXIT button repeatedly to return.

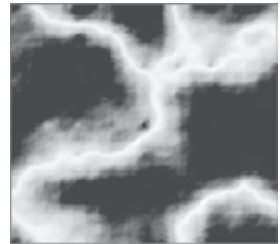
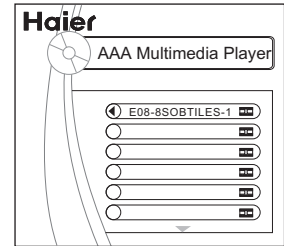
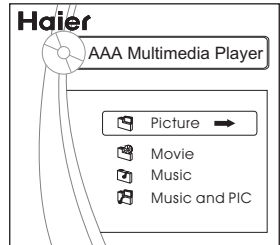

# Stream media broadcast system

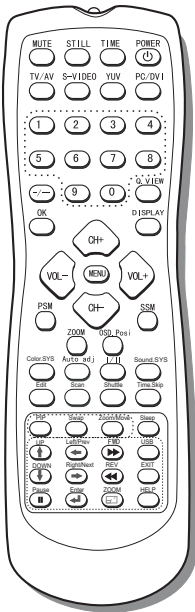

## To select the Music and PIC item

1. Press UP/DOWN button to select "Music and PIC" option, and press ENTER button to enter menu.

2. Press UP/DOWN to select desired file, and press → button to ensure it. (← to cancel). Repeat step 2 to select more file, and press ENTER button to enter play menu.

3. On screen display menu, press UP/DOWN to select the speed to play. (**Normal, slow, fast**).

4. Press FWD▶▶ or REV◀◀ button to swap the next and previous picture, press LEFT◀ or RINGHT▶ button to select the music.

**Note:** press PAUSE button to stop playing the picture.

5. Press repeatedly EXIT button to return.

**Note:** on the music and picture, the playing music is \*.mp3 format.

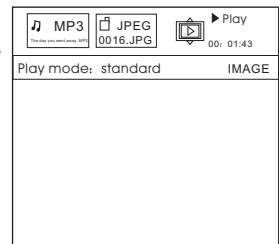
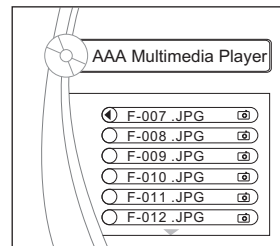
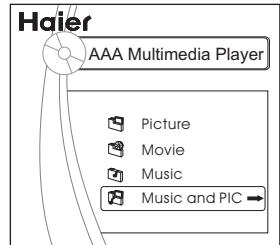

# Stream media broadcast system

## Copy file function

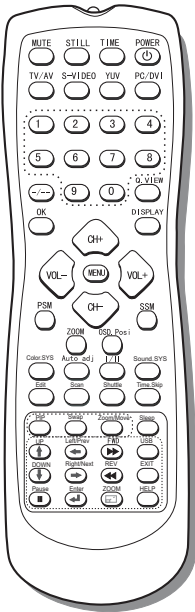

### Note:

RIGHT button to select the all files;  
LEFT button to cancel.

1. Press UP/DOWN to select "File Copy" item.
2. Press ENTER button to enter the copy menu.
3. Press ENTER button to enter the file menu, and press UP/DOWN button to select "Card" or "USB".
4. Press ENTER button to enter card or USB, and select the files to copy, then press HELP button to call up COPY and PASTE, and then press UP/DOWN button to select COPY, and press ENTER button to confirm, press again UP/DOWN button to select PASTE, then press ENTER button to paste, in this time, the "File already exists, overwrite it?" will appears on the screen, and press LEFT/RIGHT button to select YES/NO, and then press ENTER button to confirm.
5. Press ENTER to cancel.

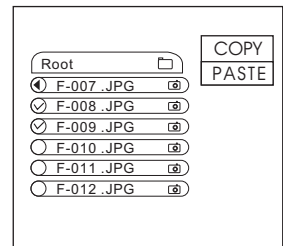
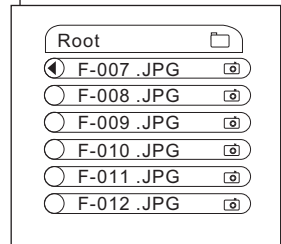
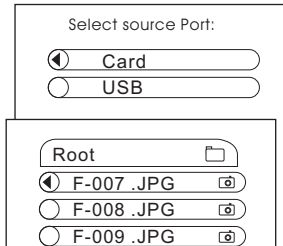
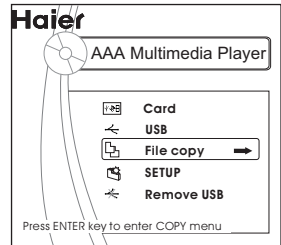

# Stream media broadcast system

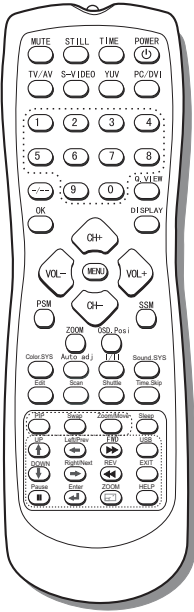

## To select language

1. Press UP/DOWN to select "SETUP " item.
2. Press ENTER button to enter the SETUP menu,
3. and press again ENTER button to enter language option.
4. Press UP/DOWN to select desired language, and press ENTER to ensure it.
5. Press EXIT button to return.

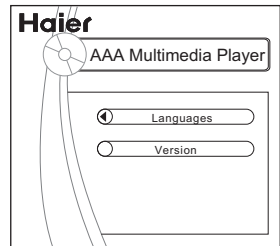
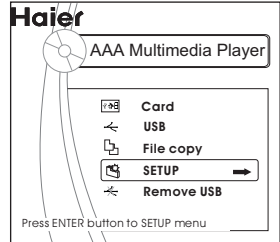

## To display the version

1. Repeat steps 1-2, and then press UP/DOWN to select version.
2. Press ENTER button to display the version number.

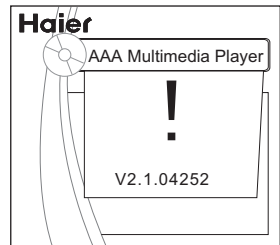

# Specifications and functions

Picture proportions 4:3/wide screen: (3 modes)  
Panorama picture: 16:9  
Picture element: 1366×768  
Multi-input compatibility  
Advanced technology for motion picture processing  
Two speakers/optional

Complex component: RCA-pin×3  
Component video signal: YUV×1  
S terminal: Mini DIN 4-pin×1  
RGB input: D-sub 15-pin×1 (480i/p, 720p, 1080i, 1080p)  
Audio input: RCA-pin TYPE (L/R)×4: full support  
separate audio frequency input  
Audio system: stereo  
Control port: RS-232 D-sub 9-pin×1

Size: (WxDxH) unit: 1270mmX380mmX788mm  
(stand and speaker included)

## Working conditions

Power: ~150V-240V, 50/60Hz  
Power consumption: ≤240W

## Temperature

Working: 0°C~35°C    Storage: -25°C~45°C

## Humidity

Working: 20~80%    Storage: 5~90%

# Maintenance

---

- Early malfunctions can be prevented. Careful and regular cleaning can extend the amount of time you will have your new TV. Be sure to turn the power off and unplug the power cord before you begin any cleaning.

## Cleaning the Screen

1. Here's a great way to keep the dust off your screen for a while. Wet a soft cloth in a mixture of lukewarm water and a little fabric softener or dish washing detergent. Wring the cloth until it's almost dry, and then use it to wipe the screen.

2. Make sure the excess water is off the screen, and then let it air-dry before you turn on your TV.

## Cleaning the Cabinet

To remove dirt or dust, wipe the cabinet with a soft, dry, lint-free cloth. Please be sure not to use a wet cloth.

## Extended Absence

If you expect to leave your TV dormant for a long time (such as a vacation), it's a good idea to unplug the power cord to protect against possible damage from lightning or power surges.

# Troubleshooting

For the sake of time and cost, it is strongly recommended that you check out the problem by yourself according to the instructions listed hereunder before contacting the after-sales service for technical assistance.

<b>Problem</b>	<b>Possible remedies</b>
No picture, no sound	Turn on the power supply; Properly plug the TV set to the power socket; Check to see if the power cable of other appliance is plugged in the TV set. Make sure that the power cable of the TV set is properly connected.
Good picture, no sound	Depress the volume button; Check out the audio frequency inputs signals.
Failure of remote controller	Check to see if the remote controller display receiving window are blocked by other objects and if batteries are properly loaded.
No color, weak color or poor picture	Designate the item of color from the Picture menu and depress the volume button; Keep the display and VCR separate a reasonable space; Activate some functions to store picture brightness; Make sure that the display and signal source are available and turned on.
Excessive brightness or darkness	Adjust brightness or contrast.
Picture too big or small	Adjust the setup of sizes.
One speaker failure	Balance the sound in the menu.
Slight sound from display	It is a normal phenomenon.

**Note:** Do not leave the television with static picture in an extended period as it may result in residual image on your television screen.

**Note:** Production of the screen requires high and precision technologies. However, there might be some dark or bright (red, blue or green) spots, or some anomalistic stripes or spots. This is not defect. If the TV set is used in an area 2,400 meters above the sea level where the air pressure is below 750hpa, the picture on the screen may be affected and a muffled sound might be produced. These phenomena might happen in the area 1,500 meters above the sea level. This is resulted from difference between air pressures inside and outside the display. This is not a defect covered by the limited warranty.

## **NOTE**

Design and specifications are subject to change without notice.  
The dimension in this manual is a approximation.



# Haier



01  
0090506976